

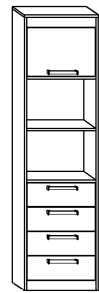

MXS-29 REGAŁ W1D4S

→ 52+193\36



| | | | | | | | | |
|--------------|----------------------------|--------------|---------------|---------------|---------------------------|---------------------------|---------------|--------------|
| x 8 a | x 22 b | x 2 c | x 24 d | x 16 e | x 4 f | | | |
| x 2 g | x 2 h | x 4 i | x 4 j | x 5 k | x 62 (3,5x16) l | x 16 (3,5x30) m | x 90 n | x 1 o |
| x 5 p | x 4 kpl. (300 mm) r | | | | | 60 min | | |

1 - FAZY MONTAŻU

A - OZNACZENIE ELEMENTÓW

a - OZNACZENIE AKCESORIÓW

1

x 2 a x 4 b x 2 c

2

x 6 a x 16 b x 4 i x 4 j x 4 k x 32 (3,5x16) l x 4 kpl. r (L, P)

3

x 2 b x 2 d

4

x 16

d

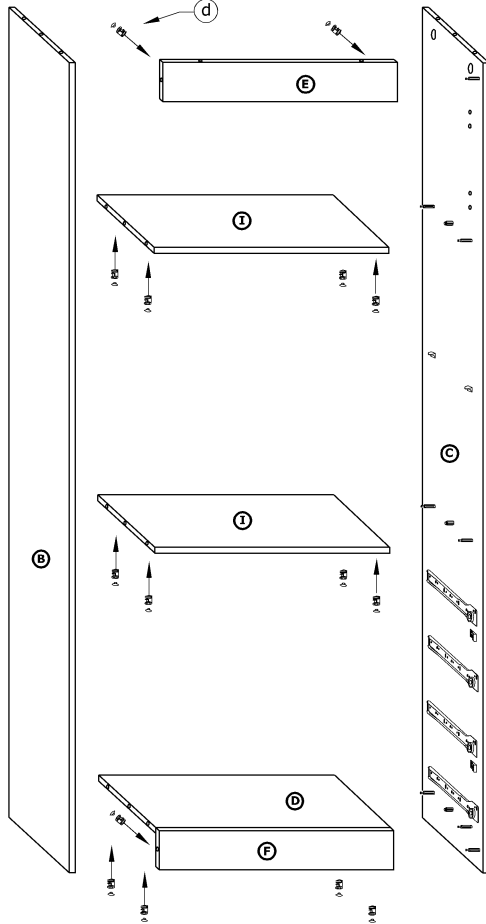
**5**

x 6

d

x 30

n

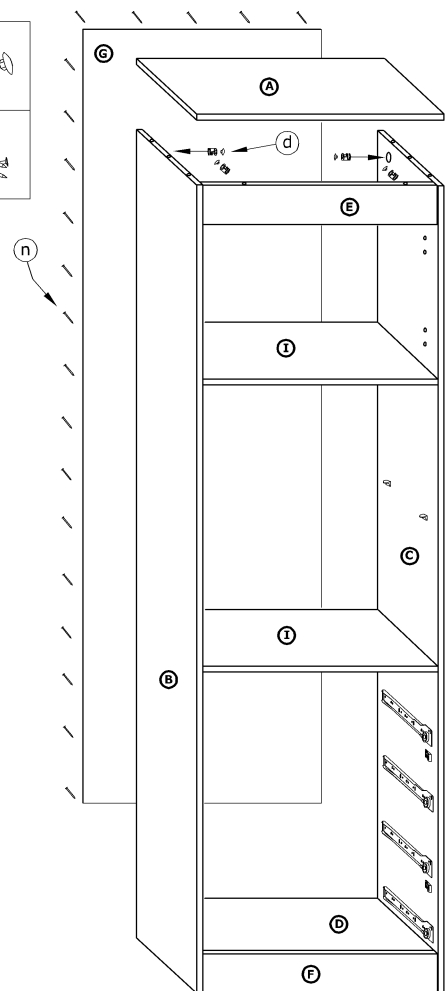
**6**

x 16

e

x 8

f

x 24

(3,5x16)

l

x 8

(3,5x30)

m

x 60

n

x 4 kpl.

r

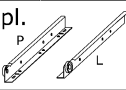
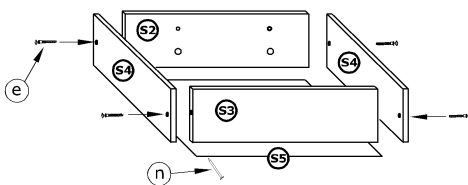
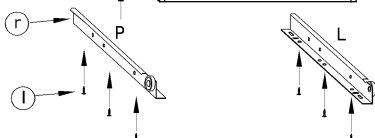
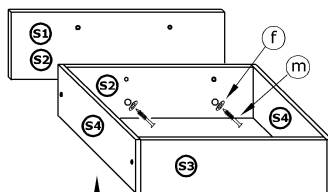
**X 4****X 2 - S1****X 2 - S2****7**

x 2

g

x 2

h

x 1

k

x 6

(3,5x16)

x 8

(3,5x30)

x 5

p

